

Inventor Import for AutoCAD Help

Table Of Contents

Inventor Import for AutoCAD Help.....	1
Introduction	2
License Agreement	4
ReadMe	11
Contact.....	13
Command Reference	14
InventorImport.....	15
InventorImportHelp.....	16
InventorImportRegister	17
InventorImportAbout	19
Tutorial	20

Inventor Import for AutoCAD Help

Welcome to *Inventor Import for AutoCAD* Help!

This help file provides all the information you need to understand and use *Inventor Import for AutoCAD*. Click the links below or use the Contents tab on the left to browse help topics. You can also scroll the topics on the above right hand pane.

The *Inventor Import for AutoCAD* help file is divided into the following sections:

- [Introduction](#) - Introduction to *Inventor Import for AutoCAD*.
- [Command Reference](#) - Quick reference of all the commands added by *Inventor Import for AutoCAD*.
- [Tutorial](#) - Tutorial to get you started in the shortest possible time.

If you need any additional information please [contact](#) SYCODE.

Note:

- Please refer to the section "Loading Instructions" in the [ReadMe](#) file to load *Inventor Import for AutoCAD* plug-in file into the AutoCAD environment.
- Please read the [License Agreement](#) before using the software.

Introduction

Inventor Import for AutoCAD is a plug-in for AutoCAD. This plug-in gives AutoCAD the ability to import 3D solid data from Inventor part (IPT) and assembly (IAM) files.

Inventor Import for AutoCAD creates true 3D solids in AutoCAD which can then be edited using AutoCAD's solid modeling tools just like any other 3D solid. This plug-in does not need Inventor to be installed on the computer or on the network.

Inventor Import for AutoCAD is powered by the widely used 3D InterOp technology from Spatial. 3D InterOp is the industry standard for proprietary CAD file format data exchange and is used in almost all the major CAD systems. Besides data exchange 3D InterOp also offers powerful repairing and healing features which are extensively used in *Inventor Import for AutoCAD*. Repairing involves checking the file for corrupted data and fixing the invalid data. Healing corrects the differences in precision. *Inventor Import for AutoCAD* also creates a detailed log file which is extremely useful in identifying data translation problems and aids in locating and fixing errors.

Inventor Import for AutoCAD can import Inventor part IPT files from Inventor 6 to Inventor 2010 and assembly IAM files from Inventor 11 to Inventor 2010

Inventor Import for AutoCAD is designed to work with the following versions of AutoCAD:

- AutoCAD 2011 (32 & 64 Bit)
- AutoCAD 2010 (32 & 64 Bit)
- AutoCAD 2009 (32 & 64 Bit)
- AutoCAD 2008 (32 & 64 Bit)
- AutoCAD 2007
- AutoCAD 2006
- AutoCAD 2005
- AutoCAD 2004
- AutoCAD 2002
- AutoCAD 2000i
- AutoCAD 2000

Note: When importing an Inventor assembly IAM file, please ensure that all referenced part IPT files are located in the root folder as the assembly IAM file.

Inventor Import for AutoCAD is very easy to use. Once installed, it must be loaded into the AutoCAD environment. There are simple instructions for this in the [ReadMe](#) file. Once loaded it adds new commands to AutoCAD's existing commands and a new submenu called "InventorImport" to the AutoCAD menu containing these newly added commands.

Inventor Import for AutoCAD comes with detailed documentation as well as a [tutorial](#) to get you started in the shortest possible time.

If you need any additional information please [contact](#) SYCODE.

About Autodesk Inventor

Autodesk Inventor, developed by Autodesk, is 3D parametric solid modeling software for creating 3D mechanical models. Inventor software is a history-based parametric solid modeler. With Inventor, you create digital objects that simulate physical objects. Inventor models are accurate 3D digital prototypes. Autodesk calls its approach to model design "digital prototyping". With the parametric modeling tools in Inventor, you can apply driving dimensions and geometric relationships to an object. These dimensions and relationships are called parameters. The size and shape or geometry of an object depends upon dimensions and relationships to other parts. When one part is changed, the object automatically updates to reflect the change

Inventor uses proprietary file formats for parts (IPT), assemblies (IAM), and drawing views (IDW or DWG).

License Agreement

SYCODE END USER LICENSE AGREEMENT

READ CAREFULLY: SYCODE LICENSES THIS SOFTWARE TO YOU ONLY UPON THE CONDITION THAT YOU ACCEPT ALL OF THE TERMS CONTAINED IN THIS SOFTWARE LICENSE AGREEMENT.

BY SELECTING THE "I ACCEPT" BUTTON AT THE END OF THIS AGREEMENT OR BY COPYING, INSTALLING, UPLOADING, ACCESSING OR USING ALL OR ANY PORTION OF THE SOFTWARE YOU AGREE TO ENTER INTO THIS AGREEMENT. A CONTRACT IS THEN FORMED BETWEEN SYCODE AND EITHER YOU PERSONALLY, IF YOU ACQUIRE THE SOFTWARE FOR YOURSELF, OR THE COMPANY OR OTHER LEGAL ENTITY FOR WHICH YOU ARE ACQUIRING THE SOFTWARE.

IF YOU DO NOT AGREE OR DO NOT WISH TO BIND YOURSELF OR THE ENTITY YOU REPRESENT: (A) DO NOT COPY, INSTALL, DOWNLOAD, ACCESS OR USE THE SOFTWARE; (B) SELECT "I REJECT" AT THE END OF THIS AGREEMENT (WHICH WILL CANCEL THE LOADING OF THE SOFTWARE); AND (C) WITHIN THIRTY (30) DAYS FROM THE DATE OF ACQUISITION, RETURN THE SOFTWARE TO THE LOCATION WHERE YOU ACQUIRED IT FOR A REFUND.

COPYING OR USE OF THIS SOFTWARE OR ANY ACCOMPANYING DOCUMENTATION EXCEPT AS PERMITTED BY THIS AGREEMENT IS UNAUTHORIZED AND CONSTITUTES A MATERIAL BREACH OF THIS AGREEMENT AND AN INFRINGEMENT OF THE COPYRIGHT AND OTHER INTELLECTUAL PROPERTY RIGHTS IN SUCH SOFTWARE AND DOCUMENTATION. IF YOU COPY OR USE ALL OR ANY PORTION OF THIS SOFTWARE OR ITS USER DOCUMENTATION WITHOUT ENTERING INTO THIS AGREEMENT OR OTHERWISE OBTAINING WRITTEN PERMISSION OF SYCODE, YOU ARE VIOLATING COPYRIGHT AND OTHER INTELLECTUAL PROPERTY LAW. YOU MAY BE LIABLE TO SYCODE AND ITS LICENSORS FOR DAMAGES, AND YOU MAY BE SUBJECT TO CRIMINAL PENALTIES.

1. DEFINITIONS

1.1 "Access" means to use or benefit from using the functionality of the Software.

1.2 "Computer" means a single electronic device with one or more central processing units (CPUs) that accepts information in digital or similar form and manipulates the information for a specific result based on a sequence of instructions.

1.3 "Install" means to place a copy of Software onto a hard disk or other storage medium through any means (including, but not limited to, use of an installation utility application accompanying the Software).

1.4 "License Parameters" means the definition and limitation of the applicable license scope in Section 2.2 hereof.

1.5 "Permitted Number" means a number relevant for the applicable License Parameters that SYCODE may specify in the applicable User Documentation. The Permitted Number is one (1) unless otherwise provided by SYCODE in writing.

1.6 "Software" means the computer program in which this Agreement is embedded or that is delivered prepackaged with this Agreement.

1.7 "User Documentation" means the explanatory printed or electronic materials that SYCODE or its authorized distributor incorporates in or delivers in or on a package with the Software or sends to You on an invoice, via email, facsimile or otherwise after You acquire or Install the Software, including, but not limited to, license specifications, activation key, license files, instructions on how to use the Software, and/or technical specifications.

1.8 "You" means you personally (i.e., the individual who reads and is prompted to accept this Agreement) if you acquire the Software for yourself or the company or other legal entity for whom you acquire the Software.

2. SOFTWARE LICENSE

2.1 License Grant. SYCODE grants You a non-sublicensable, non-exclusive, non-transferable, limited license to use copies of the Software in the jurisdiction in which you acquire the Software, in accordance with the applicable User Documentation, within the scope of the License Parameters. SYCODE's license grant is conditioned on Your continuous compliance with all license limitations and restrictions described in this Agreement. If You violate any of these limitations or restrictions, the license grant will automatically and immediately expire. The license descriptions in this Section 2 define the scope of rights that SYCODE grants to You. Any usage of the Software outside the scope of the applicable license grant constitutes an infringement of SYCODE's intellectual property rights as well as a material breach of this Agreement.

2.2 License Parameters. SYCODE's license grant is subject to one or more of the License Parameters defined in this Section 2.2 as specified in the User Documentation. Unless SYCODE expressly specifies or agrees otherwise in the User Documentation, all Software shall be governed solely by a license for Standalone (Individual) Versions (see Section 2.2.1).

2.2.1 Standalone (Individual) Version. If SYCODE identifies the Software as a "Standalone Version" or as an "Individual Version" or if the User Documentation does not identify the Software by any of the version designations set forth in Sections 2.2.2 through 2.2.6, You may Install and Access one (1) copy of the Software on one (1) individual Computer, which may not be connected to a network in a manner that allows more than one (1) user to access, upload, operate, view or otherwise create or use a copy of the Software. You may not install or access the Software other than on one (1) computer at a time.

2.2.2 Network Version. If SYCODE identifies the Software as a "Network Version" in the applicable User Documentation, You may Install, Access and use one (1) copy of the Software on Your Computer file server, for Your own internal business needs, with the SYCODE License Manager tool. The Software may be Installed on or Accessed by other Computers, or on an individual Computer, as a multiple-user installation, so long as the

maximum number of concurrent users does not to exceed the Permitted Number.

2.2.3 Educational Institutional Version. If SYCODE identifies the Software as an "Educational Institutional Version" in the applicable User Documentation, You may Install and Access a single copy of the Software on up to the Permitted Number of Computers, only for educational purposes (as further specified in the applicable User Documentation) and for no other purpose. Without limiting the foregoing, Educational Institutional Versions of the Software may not be used for commercial, professional, or for-profit purposes. Additionally, functional limitations apply, as set forth in Section 6.

2.2.4 Student Version. If SYCODE identifies the Software as a "Student Version" in the applicable User Documentation, You may Install and Access a single copy of the Software on up to the Permitted Number of Computers, only for personal learning purposes, and no other purpose. Unless otherwise provided by SYCODE in the User Documentation, Student Versions of the Software may be used for a period of one (1) year from the date of Installation. Without limiting the foregoing, Student Versions of the Software may not be used for commercial, professional or other for-profit purposes and may only be used by persons who qualify as a permitted user of Student Versions (as further specified in the applicable User Documentation for the jurisdiction in which the Software is acquired). Additionally, functional limitations apply, as set forth in Section 6.

2.2.5 Evaluation Version. If SYCODE identifies the Software as a demonstration, evaluation, trial, or not for resale version ("Evaluation Version") in the applicable User Documentation, You may Install and Access one copy of the Software only for the purpose of commercial evaluation and demonstration. Without limiting the foregoing, You may not use it for competitive analysis, or commercial, professional, or for-profit purposes. The Evaluation Version may only be Installed for a ten (10) day evaluation period, unless otherwise specified by SYCODE in writing. Additionally, functional limitations apply, as set forth in Section 6.

2.2.6 License Term. Subject to the terms and conditions of this Agreement, the license to use the Software is perpetual, unless the Software qualifies as an Evaluation Version, Student Version, or is designated as a fixed-term license, a limited duration license or a rental license. In such case, the term of the license shall be the term identified by SYCODE in the applicable User Documentation (the "Designated Term") or the term for which You have paid, whichever is less. If SYCODE identifies the Software as licensed for a fixed term, limited duration or rental and does not specify a term, then the Designated Term shall expire thirty (30) days after the date You first Install the Software. Use of this Software beyond the applicable license term, or any attempt to defeat the time-control disabling function in the Software is an unauthorized use and constitutes a material violation of this Agreement and intellectual property law.

2.3 Software Components. The Software is licensed to You as a single product and its components may not be separated for distribution or use on more than one (1) Computer unless expressly permitted by SYCODE in the applicable User Documentation.

3. PERMITTED AND PROHIBITED ACTIONS

3.1 Permitted Actions

3.1.1 Backup Copy. Regardless of which version of the Software You have acquired, You may Install one archival (backup) copy of the Software. Such archival copy may not be

Installed on another Computer, unless such other Computer is a partitioned drive of a server to which only the user of the active copy of the Software can Access. In any event, the archival copy may not be Accessed as long as another copy of the Software is Installed on any Computer. Except as expressly permitted under Section 2.2: (a) if the User Documentation is in printed form, it may not be copied; and (b) if the User Documentation is in electronic form, it may not be duplicated electronically.

3.1.2 Additional Installation. Except with regard to Educational Institutional, Student and Evaluation Versions only, You may Install and Access a second copy of the Software on the hard disk of a second Computer owned by You or under Your control provided that:

(i) the original and second copies are used only by the same person;

(ii) the second copy is Installed and Accessed only on either (a) with respect to Network Versions, a redundant server that makes the Software available for use only when Your primary server on which the active Software copy is Installed becomes inoperable, or (b) a notebook computer or other non-server computer away from Your usual work location for the purpose of enabling You to perform work while away from Your usual work location;

(iii) only one of the Software copies is Accessed at any one time; and

(iv) both copies of the Software are Installed and Accessed exclusively with the copy protection device (if any) supplied with the Software.

(v) You have an active Subscription for the Software.

3.2 Prohibited Actions. SYCODE does not permit any of the following actions and You acknowledge that such actions shall be prohibited:

3.2.1 Use. You may not Install, Access or otherwise copy or use the Software or User Documentation except as expressly authorized by this Agreement.

3.2.2 Reverse Engineering. You may not reverse engineer, decompile, or disassemble the Software.

3.2.3 Transfers. You may not distribute, rent, loan, lease, sell, sublicense, or otherwise transfer all or any portion of the Software or User Documentation, or any rights granted in this Agreement, to any other person without the prior written consent of SYCODE.

3.2.4 Hosting or Third Party Use. You may not Install or Access, or allow the Installation or Access of, the Software over the Internet, including, without limitation, use in connection with a Web hosting or similar service, or make the Software available to third parties via the Internet on Your computer system or otherwise.

3.2.5 Distribution. You may not distribute the Software to another party, without prior written permission from SYCODE. Distribution includes, but is not limited to, sending the Software by electronic mail, placing the Software on a web server or a similar on-line source, including the software on a CD or any other media or any other distribution mechanism.

3.2.6 Notices. You may not remove, alter, or obscure any proprietary notices, labels, or marks from the Software or User Documentation.

3.2.7 Modifications. You may not modify, translate, adapt, arrange, or create derivative works based on the Software or User Documentation for any purpose.

3.2.8 Circumvention. You may not utilize any equipment, device, software, or other means designed to circumvent or remove any form of copy protection used by SYCODE in connection with the Software, or use the Software together with any, activation code, serial number, or other copy protection device not supplied by SYCODE directly or through an authorized distributor.

3.2.9 Export. You may not export the Software or User Documentation in violation of this Agreement, Indian or other applicable export control laws.

4. ALL RIGHTS RESERVED

Except as expressly provided otherwise in this Agreement, title, ownership and all rights and interest including, without limitation, copyrights, in and to the Software and User Documentation and any authorized copies made by You remain with SYCODE and its licensors. The structure, organization, and code of the Software are valuable trade secrets of SYCODE and its licensors and You shall keep such trade secrets confidential. The Software and User Documentation are licensed, not sold.

5. DISCLAIMER

ANY STATEMENTS OR REPRESENTATIONS ABOUT THE SOFTWARE AND ITS FUNCTIONALITY IN THE USER DOCUMENTATION OR ANY COMMUNICATION WITH YOU CONSTITUTE TECHNICAL INFORMATION AND NOT AN EXPRESS WARRANTY OR GUARANTEE. IN ADDITION, SYCODE SPECIFICALLY DISCLAIMS ANY OTHER WARRANTY INCLUDING, WITHOUT LIMITATION, THE IMPLIED WARRANTY OF MERCHANTABILITY, FITNESS FOR A PARTICULAR PURPOSE AND NON-INFRINGEMENT. WITHOUT LIMITING THE FOREGOING, SYCODE DOES NOT WARRANT THAT THE OPERATION OF THE SOFTWARE WILL BE UNINTERRUPTED OR ERROR FREE.

6. WARNINGS

6.1 Functionality Limitations. COMPUTER AIDED DESIGN SOFTWARE AND OTHER TECHNICAL SOFTWARE ARE TOOLS INTENDED TO BE USED BY TRAINED PROFESSIONALS ONLY. THEY ARE NOT SUBSTITUTES FOR YOUR PROFESSIONAL JUDGMENT. COMPUTER AIDED DESIGN SOFTWARE AND OTHER TECHNICAL SOFTWARE ARE INTENDED TO ASSIST WITH PRODUCT DESIGN AND ARE NOT SUBSTITUTES FOR INDEPENDENT TESTING OF PRODUCT STRESS, SAFETY AND UTILITY. DUE TO THE LARGE VARIETY OF POTENTIAL APPLICATIONS FOR THE SOFTWARE, THE SOFTWARE HAS NOT BEEN TESTED IN ALL SITUATIONS UNDER WHICH IT MAY BE USED. SYCODE SHALL NOT BE LIABLE IN ANY MANNER WHATSOEVER FOR THE RESULTS OBTAINED THROUGH THE USE OF THE SOFTWARE. PERSONS USING THE SOFTWARE ARE RESPONSIBLE FOR THE SUPERVISION, MANAGEMENT AND CONTROL OF THE SOFTWARE. THIS RESPONSIBILITY INCLUDES, BUT IS NOT LIMITED TO, THE DETERMINATION OF APPROPRIATE USES FOR THE SOFTWARE AND THE SELECTION OF THE SOFTWARE AND OTHER PROGRAMS TO ACHIEVE INTENDED RESULTS. PERSONS USING THE SOFTWARE ARE ALSO RESPONSIBLE FOR ESTABLISHING THE ADEQUACY OF INDEPENDENT PROCEDURES FOR TESTING THE RELIABILITY AND ACCURACY OF ANY

PROGRAM OUTPUT, INCLUDING ALL ITEMS DESIGNED BY USING THE SOFTWARE.

6.2 Activation Key Required.

6.2.1 INSTALLATION, ACCESS, TRANSFERS AND CONTINUED USE OF THE SOFTWARE MAY REQUIRE AN ACTIVATION KEY. YOU MUST REGISTER YOUR ACQUISITION OF THE SOFTWARE WITH SYCODE BEFORE AN ACTIVATION KEY IS ISSUED TO YOU.

6.2.2 THE ACTIVATION SECURITY MECHANISMS MAY DISABLE THE SOFTWARE IF YOU TRY TO TRANSFER IT TO ANOTHER COMPUTER, IF YOU TAMPER WITH THE DATE SETTING MECHANISMS ON YOUR COMPUTER, IF YOU USE THE SOFTWARE PAST AN APPLICABLE EVALUATION PERIOD OR LIMITED TERM, OR IF YOU UNDERTAKE CERTAIN OTHER ACTIONS THAT MAY OFFSET THE SECURITY MODE. MORE INFORMATION IS CONTAINED IN THE APPLICABLE USER DOCUMENTATION OR AVAILABLE FROM SYCODE ON REQUEST.

7. LIMITATION OF LIABILITY

IN NO EVENT SHALL SYCODE OR ITS LICENSORS HAVE ANY LIABILITY FOR ANY INCIDENTAL, SPECIAL, INDIRECT, OR CONSEQUENTIAL DAMAGES, LOSS OF PROFITS, REVENUE, DATA, OR COST OF COVER. IN ADDITION, IN NO EVENT SHALL THE LIABILITY OF SYCODE OR ITS LICENSORS FOR ANY DAMAGES ARISING OUT OF OR IN CONNECTION WITH THE SOFTWARE OR THIS AGREEMENT EXCEED THE AMOUNT PAID OR PAYABLE BY YOU FOR THE SOFTWARE PRINCIPALLY RESPONSIBLE FOR SUCH DAMAGES. THE LIMITATIONS OF LIABILITY IN THIS SECTION 7 SHALL APPLY TO ANY DAMAGES, HOWEVER CAUSED AND REGARDLESS OF THE THEORY OF LIABILITY, WHETHER DERIVED FROM CONTRACT, TORT (INCLUDING, BUT NOT LIMITED TO, NEGLIGENCE), OR OTHERWISE, EVEN IF SYCODE HAS BEEN ADVISED OF THE POSSIBILITY OF SUCH DAMAGES AND REGARDLESS OF WHETHER THE LIMITED REMEDIES AVAILABLE HEREUNDER FAIL OF THEIR ESSENTIAL PURPOSE.

8. GENERAL

8.1. No Assignment; Insolvency. This Agreement and any rights hereunder are non-assignable and any purported assignment shall be void. The Agreement and the licenses granted hereunder shall terminate without further notice or action by SYCODE if You become bankrupt or insolvent, make an arrangement with Your creditors or go into liquidation.

8.2. Choice of Law. This Agreement and any disputes arising out of or in connection with this Agreement shall be governed by the laws of the state of Goa in India without reference to conflict-of-laws principles and excluding the UN Convention on Contracts for the International Sale of Goods.

8.3 Entire Agreement. This Agreement and the applicable User Documentation constitute the entire agreement between You and SYCODE and supersede any other previous or contemporaneous communications, agreements, representations, or advertising with respect to the Software and User Documentation.

8.4 Severability. If and to the extent any provision of this Agreement is held illegal,

invalid, or unenforceable in whole or in part under applicable law, such provision or such portion thereof shall be ineffective as to the jurisdiction in which it is illegal, invalid, or unenforceable to the extent of its illegality, invalidity, or unenforceability and shall be deemed modified to the extent necessary to conform to applicable law so as to give the maximum effect to the intent of the parties. The illegality, invalidity, or unenforceability of such provision in that jurisdiction shall not in any way affect the legality, validity, or enforceability of any other provision of this Agreement in any other jurisdiction.

8.5 Audits. To ensure compliance with this Agreement, You agree that upon reasonable notice, SYCODE or SYCODE's authorized representative shall have the right to inspect and audit Your Installation, Access and use of the Software. Any such inspection or audit shall be conducted during regular business hours at Your facilities or electronically. If such inspections or audits disclose that You have Installed, Accessed or permitted Access to the Software on Computer(s) in a manner that is not permitted under this Agreement, then SYCODE may terminate this Agreement immediately and You are liable to pay for any unpaid license fees as well as the reasonable costs of the audit. Nothing in this section shall be deemed to limit any legal or equitable remedies available to SYCODE for violation of this Agreement or applicable law.

8.6 Language. The English language version of this Agreement is legally binding in case of any inconsistencies between the English version and any translations.

ReadMe

This is the *Inventor Import for AutoCAD* ReadMe file.

Thank you for installing Inventor Import for AutoCAD.

Please read this ReadMe document carefully and completely. It contains important information which is vital to the proper working of Inventor Import for AutoCAD.

Since Inventor Import for AutoCAD is a plug-in for AutoCAD, it has to be loaded into the AutoCAD environment before it can be used. Loading is a one time process. Inventor Import for AutoCAD will automatically load itself into AutoCAD the next time you run AutoCAD.

The Inventor Import for AutoCAD plug-in files are installed into the Inventor Import for AutoCAD installation folder (typically "C:\Program Files\SYCODE\Inventor Import for AutoCAD\"). The plug-in files have an extension of ".arx".

The list of plug-in files along with the version of AutoCAD is shown below. Please be sure to use the plug-in file that corresponds to your version of AutoCAD.

```
InventorImport_VC60.arx    -> AutoCAD 2000, 2000i, 2002
InventorImport_VC70.arx    -> AutoCAD 2004, 2005, 2006
InventorImport_VC80.arx    -> AutoCAD 2007, 2008 (32 Bit), 2009 (32 Bit)
InventorImport_VC80x64.arx -> AutoCAD 2008 (64 Bit), 2009 (64 Bit)
InventorImport_VC90.arx    -> AutoCAD 2010 (32 Bit)
InventorImport_VC90x64.arx -> AutoCAD 2010 (64 Bit)
InventorImport_VC90.arx    -> AutoCAD 2011 (32 Bit)
InventorImport_VC90x64.arx -> AutoCAD 2011 (64 Bit)
```

To load Inventor Import for AutoCAD into AutoCAD please follow the steps listed below:

- (1) Select "Load Application..." from "Tools" menu or enter the "_APPLOAD" command.
- (2) Click the "Contents" button in "Startup Suite"
- (3) Click the "Add" button.
- (4) Browse for the plug-in file for your version of AutoCAD (see list above).
- (5) Click the "Add" button on the Add File to Startup Suite dialog box.
- (6) Click the "Close" button to close the Startup Suite dialog box.
- (7) Click the "Close" button to close the Load/Unload Applications dialog box.

Now Inventor Import for AutoCAD is completely installed and ready for use.

Usage:

=====

Inventor Import for AutoCAD adds new commands to AutoCAD. The commands

Inventor Import for AutoCAD Help

added are:

- 1) InventorImport - Imports an Inventor file.
- 2) InventorImportHelp - Displays the Inventor Import for AutoCAD help file
- 3) InventorImportRegister - Registers your copy of Inventor Import for AutoCAD
- 4) InventorImportAbout - Displays the Inventor Import for AutoCAD about box.

Sample Files:

=====

Sample Inventor files are copied into the Samples folder which is located in the Inventor Import for AutoCAD installation folder (typically "C:\Program Files\SYCODE\Inventor Import for AutoCAD\"). You can try Inventor Import for AutoCAD using these sample files.

Support:

=====

For support, please E-Mail support@sycode.com

Contact

Mailing address	S1/116, Nova Cidade Complex, NH 17, Alto Porvorim, Goa - 403521 India
Phone	+91 9822689298
Fax	+91 832 2416615
E-Mail	info@sycode.com
Web Site	http://www.sycode.com

Command Reference

Inventor Import for AutoCAD adds new commands to AutoCAD and a submenu called "InventorImport" which houses them. The new commands are:

InventorImport	Imports an Inventor file
InventorImportHelp	Displays the <i>Inventor Import for AutoCAD</i> help file
InventorImportRegister	Register your copy of <i>Inventor Import for AutoCAD</i>
InventorImportAbout	Displays the <i>Inventor Import for AutoCAD</i> about box

InventorImport

Menu Button	InventorImport > Import
Command	InventorImport

This command imports an Inventor file in AutoCAD

To import an Inventor file

1. Select *Import* from the "InventorImport" menu or type *InventorImport* at the AutoCAD command prompt and press *Enter*.
2. The AutoCAD "Open" dialog box is displayed. Browse for the Inventor file you wish to import and click *Open*.

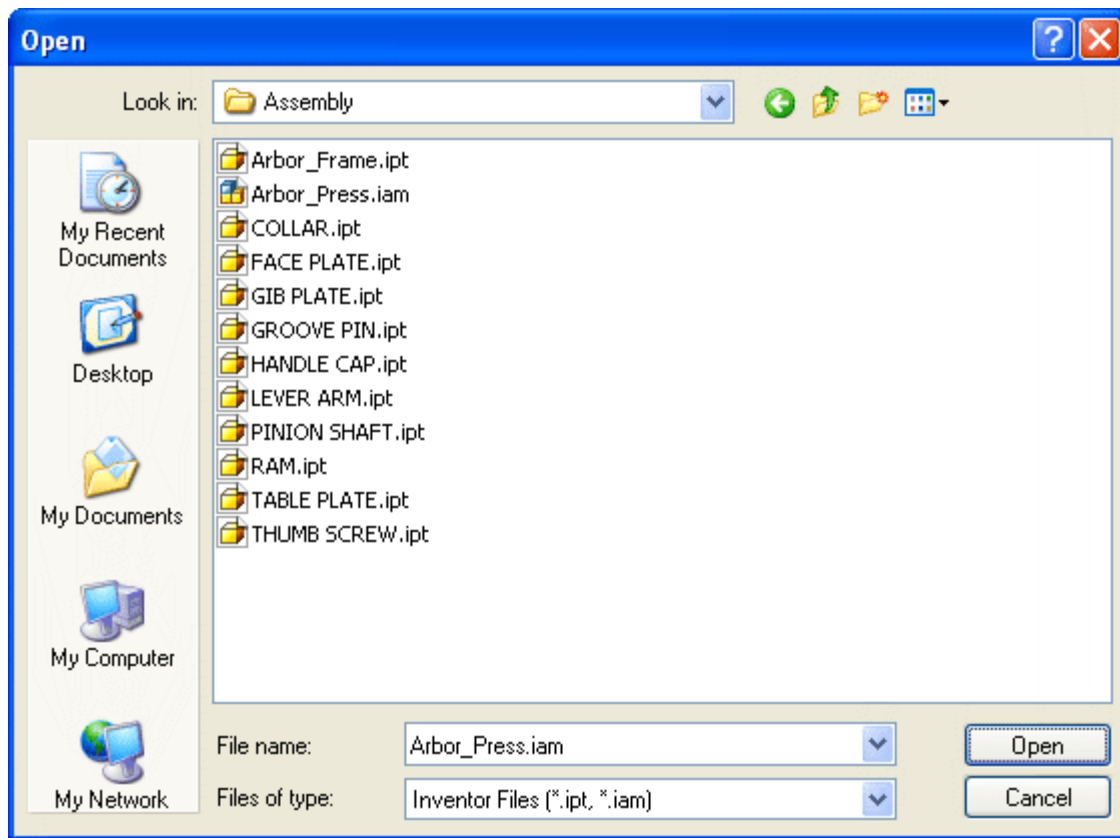

3. The "Inventor Import for AutoCAD Options" dialog box is displayed. Select the options as required and click *OK*.

InventorImportHelp

Menu Button	InventorImport > Help
Command	InventorImportHelp

This command displays the help file. The [Welcome](#) page is a good place to start.

InventorImportRegister

Menu Button	InventorImport > Register
Command	InventorImportRegister

This command is used to register your copy of *Inventor Import for AutoCAD*.

You need a license key to start using the software. A license key can be of two types: Trial or Permanent. A trial key is issued to you instantly and completely free of cost so that you may try the software before you purchase a license. A permanent key is issued after you have purchased a license.

SYCODE License Server

Product Name: Inventor Import for AutoCAD 2010 version 1.0

Host ID: 00-1D-7D-FD-AD-1D

License Key: RcaADFDD1D1U1C01fdEF0D04CN1WEE00AAVt52E'WEE04I
8R80RFa1A14p0SDiqD0SD1E7uein688CCBDhg0A14H2B1Zk
7Cfm30DDFDsdfcvcZU17095K501DAA71RF0D81DF

=== LICENSE KEY PARAMETERS ===
Key type: Trial
Expires: 24-Nov-2009
Runs remaining: 10

How do I get a Trial Key?

Simply click the 'Request Key' button and select 'TRIAL KEY' as the type of key being requested. Fill the form and submit it. A trial key will be immediately sent to you by email.

How do I get a Permanent Key?

To get a permanent key you need to have already purchased a license. If you have not yet purchased a license you can do so by clicking the 'Buy Online' button. After you place your order click the 'Request Key' button and select 'PERMANENT KEY' as the type of key being requested. Fill the form and submit it. Your order will be verified and a permanent key will be sent to you by email within one business day.

IMPORTANT:

Inventor Import for AutoCAD Help

- (1) Please ensure that your computer is connected to the internet before you request for a key.
- (2) Please be sure to enter a valid email address as the key will be sent to you by email.
- (3) To avoid disruption in your work-flow we urge you to place your order before the trial period ends.

If you need anything else please send an email to register@sycode.com

InventorImportAbout

Menu Button	InventorImport > About
Command	InventorImportAbout

This command is used to display the *Inventor Import for AutoCAD* About box. The About box lists the software and its version

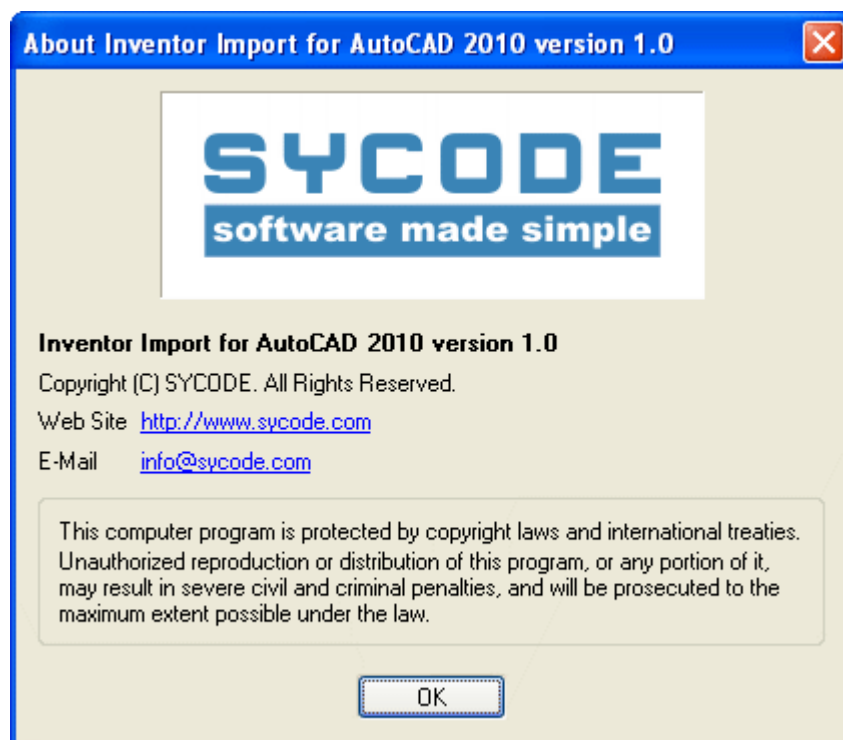

Tutorial

This tutorial provides the necessary information and hands-on experience to help you get started with *Inventor Import for AutoCAD*.

Step 1: Start AutoCAD.

Step 2: Select *Import* from the "InventorImport" menu or type *InventorImport* at the AutoCAD command prompt and press *Enter*.

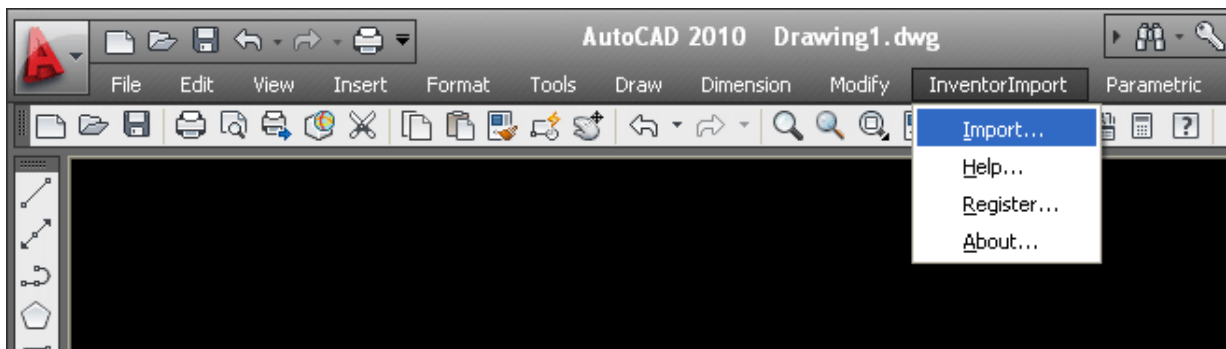

Step 3: The AutoCAD "Open" dialog box is displayed. Browse for the file located at C:\Program Files\SYCODE\Inventor Import for AutoCAD\Samples\Assembly\Arbor_Press.iam and click *Open*.

Note: To import a sample part file browse for the file located at C:\Program Files\SYCODE\Inventor Import for AutoCAD\Samples\Parts\ and click *Open*.

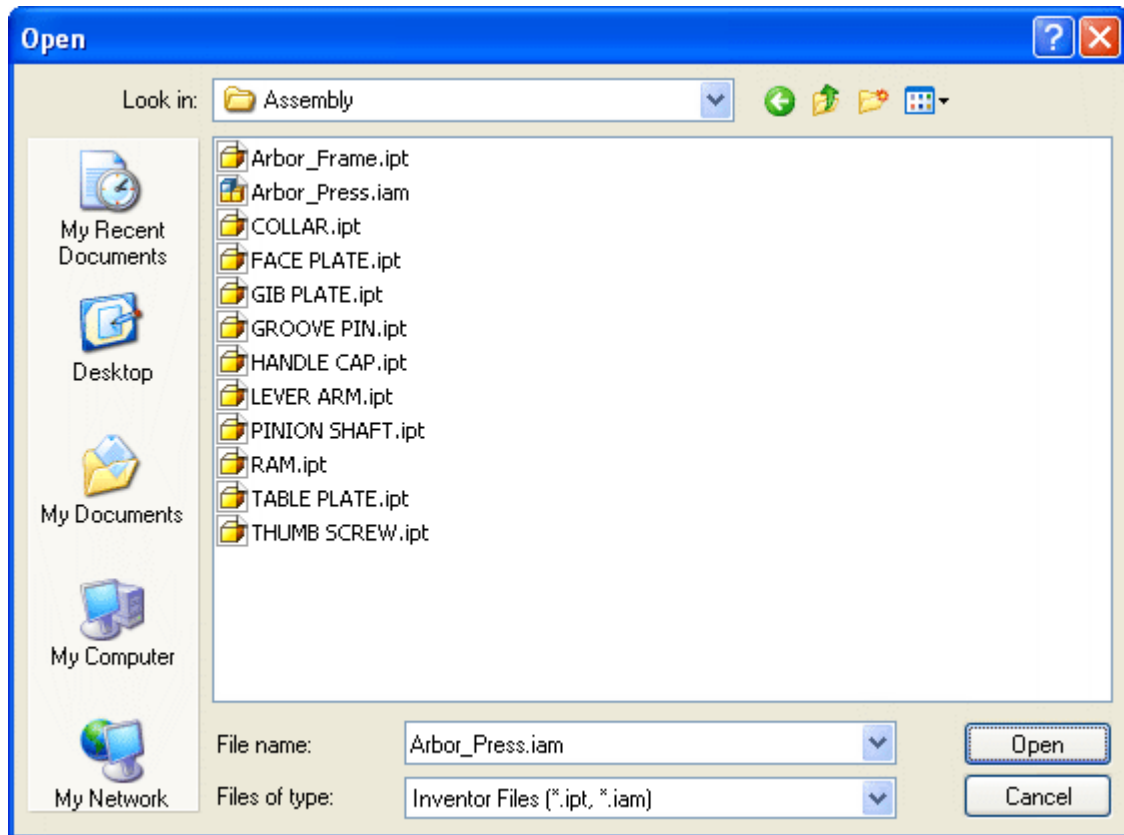

Step 4: The "Inventor Import for AutoCAD Options" dialog box is displayed. Select the options as required and click *OK*.

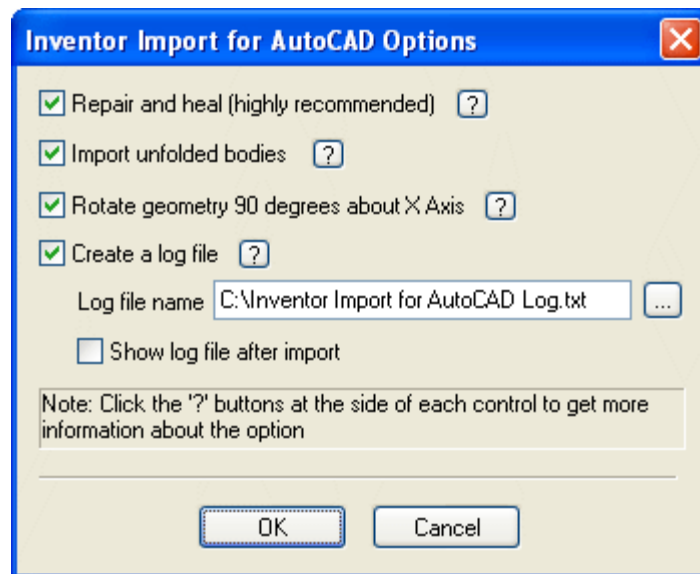

The figure below shows the final result.

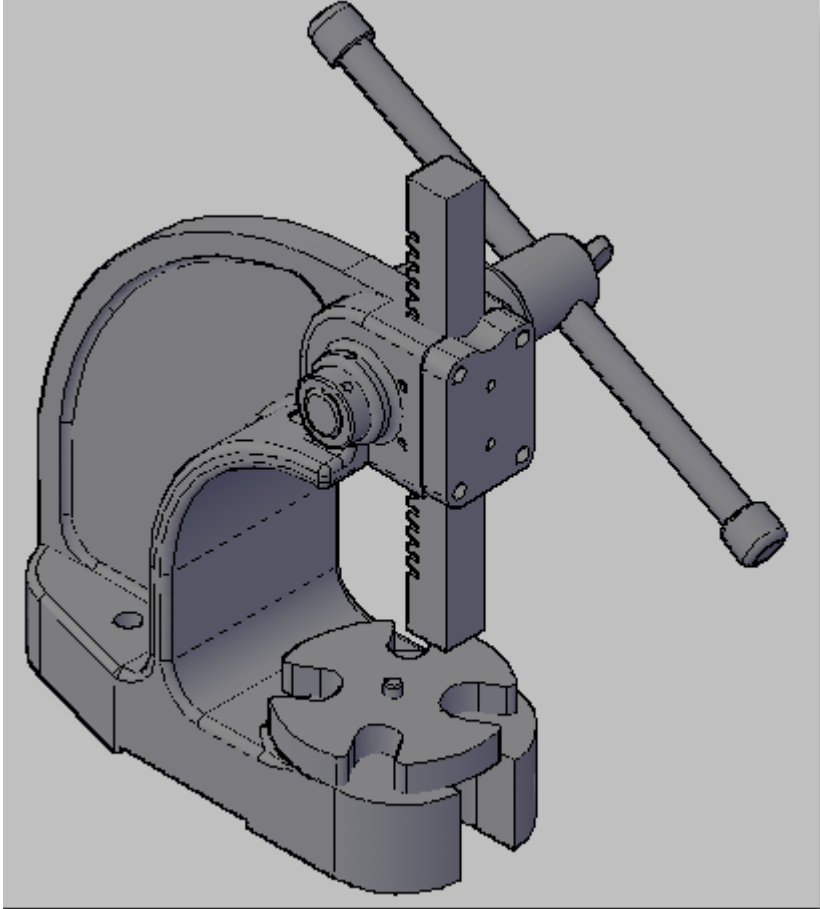

Assembly model in shaded mode

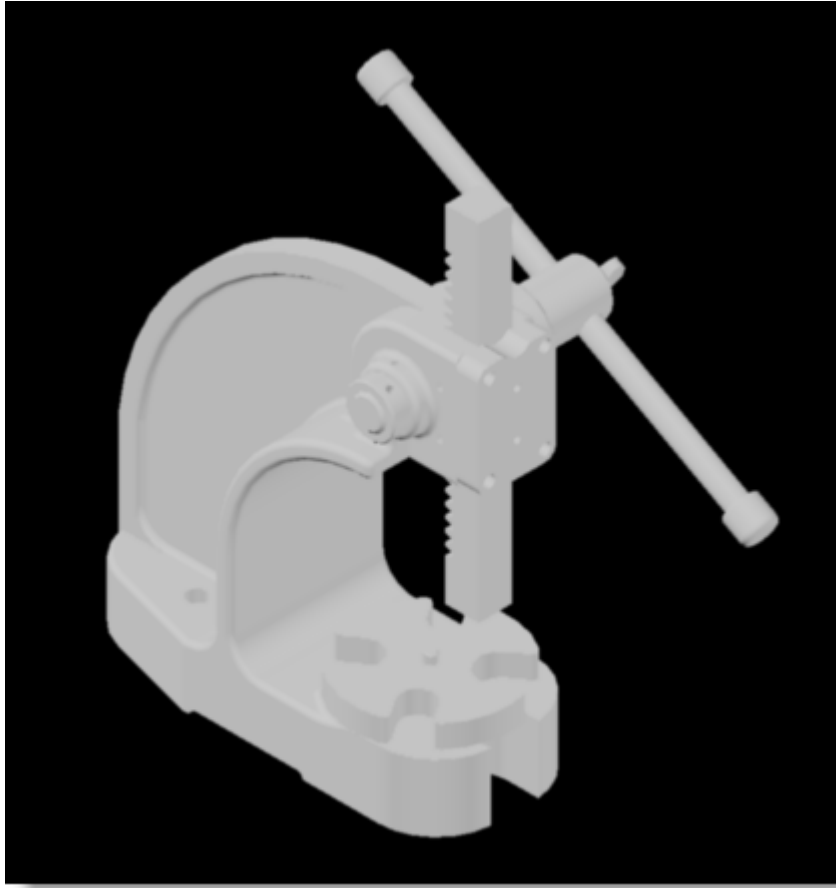

Assembly model in rendered mode